

PRODUCT SPECIFICATIONS

Elkay Fireclay 33" x 18-13/16" x 9-5/8" Single Bowl Farmhouse Workstation Sink Kit White. Sink is molded from fine fireclay with a durable porcelain glaze providing a finish that is non-porous and resists staining. Naturally sound deadening and Center Right drain placement.

Installation Type:	Farmhouse, Sink Kits
Material:	Fireclay
Special Features:	Workstation
Finish:	White (WH)
Number of Bowls:	1
Sink Dimensions:	33" x 18-13/16" x 10-1/8"
Bowl 1 Dimensions:	31-3/8" x 16-1/4" x 9-5/8"
Drain Size:	3-1/2" (89mm)
Drain Location:	Center Right
Minimum Cabinet Size:	36"
Mounting Hardware:	No
Template Included:	No



Included with Product: one LKCB1218HW cutting board, one LKOBG3015SS bottom grid, one LK99FC drain, and a LKCLKIT cleaning kit.

Special Note: Reserve Selection products are sold exclusively, in-store and online, through authorized wholesalers. Sink is reversible offering the option of a traditional flat front or a decorative band feature.



A Century of Tradition and Quality. For more than 100 years, Elkay has been making innovative products and providing exceptional customer care. We take pride in offering plumbing products that make life easier, inspire change and leave the world a better place.



Product Compliance: ASME A112.19.2/CSA B45.1
Accessory: ASME A112.18.2/CSA B125.2

Installation Profile:

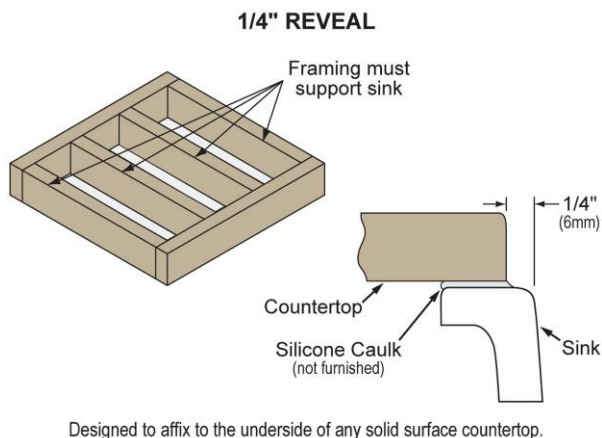

Sinks are listed by IAPMO[®] as meeting the applicable requirements of the Uniform Plumbing Code[®], International Plumbing Code[®], and National Plumbing Code of Canada.

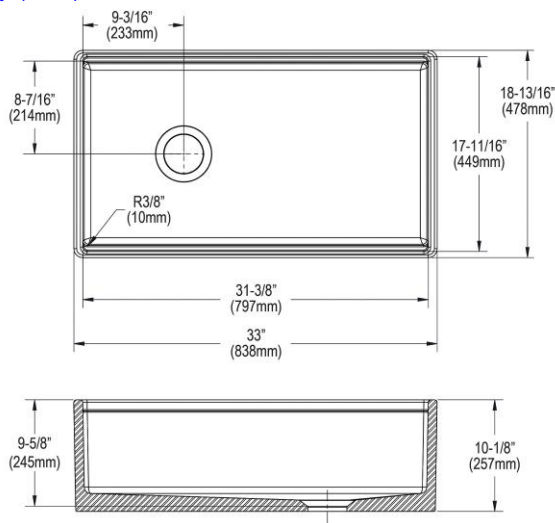

[Clean and Care Manual \(PDF\)](#)
[Installation Instructions \(PDF\) - 1000003608](#)
[Warranty \(PDF\)](#)





PART: _____ QTY: _____
 PROJECT: _____
 CONTACT: _____
 DATE: _____
 NOTES: _____
 APPROVAL: _____

Included Accessories

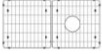
In keeping with our policy of continuing product improvement, Elkay reserves the right to change product specifications without notice. Please visit elkay.com for the most current version of Elkay product specification sheets. This specification describes an Elkay product with design, quality, and functional benefits to the user. When making a comparison of other producers' offerings, be certain these features are not overlooked.

LK99FC	Elkay Deluxe Drain 3-1/2" Type 304 Stainless Steel Body for Fireclay Sinks Spec Sheet (PDF)	
LKCB1218HW	Elkay Hardwood 12-1/2" x 17-5/16" x 1-1/2" Cutting Board Spec Sheet (PDF)	
LKOBG3015SS	Elkay Stainless Steel 30-1/4" x 15" x 1-3/8" Bottom Grid Spec Sheet (PDF)	

Optional Accessories		
LK99FCS	Elkay Deluxe Drain Kit with Satin Finish 3-1/2 Type 304 Stainless Steel Body for Fireclay Sinks Spec Sheet (PDF)	
LKEC2037	Elkay Explore Three Hole Bridge Faucet with Pull-down Spray and Lever Handles Spec Sheet (PDF)	

In keeping with our policy of continuing product improvement, Elkay reserves the right to change product specifications without notice. Please visit elkay.com for the most current version of Elkay product specification sheets. This specification describes an Elkay product with design, quality, and functional benefits to the user. When making a comparison of other producers' offerings, be certain these features are not overlooked.